

Übersicht



Rohre und Formteile Edelstahl

Rohre starr	3 - 01
Biegsame Rohre	3 - 04
Verbinder	3 - 05
Bogen	3 - 11
Abzweigungen	3 - 16
Übergangsstücke	3 - 22
Abschlüsse	3 - 29
Wartung und Regulierung	3 - 34

Aktuelle Legierungszuschläge berücksichtigen!

Rohre und Formteile Edelstahl



Wickelfalzrohr

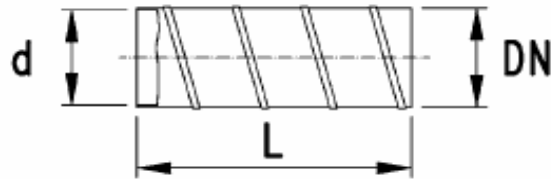

Wickelfalzrohr

WFA 1.10.13

Werkstoff: Edelstahl WSt. Nr. 1.4301

Nennweite	Wanddicke s	Gewicht	Bestell-Nr.	€/ Meter
DN	mm	kg/m		C
71	0,4	0,85	WI010201	28,00 €
80	0,4	0,95	WI010202	28,60 €
100	0,6	1,75	WI010207	35,50 €
125	0,6	2,15	WI010209	44,10 €
150	0,6	2,60	WI010211	52,60 €
160	0,6	2,75	WI010212	56,10 €
180	0,6	3,10	WI010213	63,00 €
200	0,6	3,45	WI010214	69,90 €
224	0,6	3,85	WI010215	78,40 €
250	0,6	4,30	WI010216	83,80 €
280	0,6	4,80	WI010217	97,80 €
300	0,8	6,10	WI010218	105,00 €
315	0,8	7,40	WI010219	132,90 €
355	0,8	8,30	WI010220	149,00 €
400	0,8	9,35	WI010221	170,00 €
450	0,8	10,50	WI010222	184,50 €
500	0,8	11,65	WI010223	205,00 €
560	0,8	13,00	WI010224	226,60 €
600	0,8	13,90	WI010225	245,60 €

Rohre und Formteile Edelstahl



Rohr längsgefalzt DIN EN 1506



Rohr längsgefalzt DIN EN 1506

WFA 1.10.23

Werkstoff: Edelstahl WSt. Nr. 1.4301

Nennweite	Wanddicke s	Gewicht	Bestell-Nr.	€/ Meter
DN	mm	kg/m		C
100	0,6	1,75	WI010250	44,70 €
125	0,6	2,15	WI010251	54,40 €
150	0,6	2,60	WI010252	64,50 €
160	0,6	2,75	WI010253	68,40 €
180	0,6	3,10	WI010254	69,40 €
200	0,8	3,45	WI010255	99,80 €
224	0,8	3,85	WI010256	111,00 €
250	0,8	4,30	WI010257	123,20 €
280	0,8	4,80	WI010258	137,80 €
300	0,8	6,10	WI010259	147,20 €
315	0,8	7,40	WI010260	154,20 €
355	0,8	8,30	WI010261	176,60 €
400	0,8	9,35	WI010262	198,10 €
450	0,8	10,50	WI010263	222,00 €
500	0,8	11,65	WI010264	248,50 €
560	0,8	13,00	WI010265	277,60 €
600	0,8	13,90	WI010266	296,80 €
630	1,0	18,20	WI010267	386,00 €
710	1,0	20,55	WI010268	433,90 €
800	1,0	23,10	WI010269	487,70 €
900	1,0	26,00	WI010270	547,50 €
1000	1,0	34,70	WI010271	684,70 €
1120	1,0	38,65	WI010272	765,00 €
1250	1,0	43,40	WI010273	852,00 €

Rohre und Formteile Edelstahl



Rohr längsgeschweisst DIN EN 1506

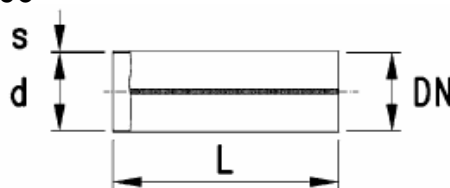

Rohr längsgeschweisst DIN EN 1506

ROA 1.10.03

Werkstoff: Edelstahl WSt. Nr. 1.4301

Nennweite	Wanddicke s	Gewicht	Bestell-Nr.	€/ Meter
DN	mm	kg/m		C
100	0,6	1,75	WI010275	46,60 €
125	0,6	2,15	WI010276	55,40 €
150	0,6	2,60	WI010277	64,60 €
160	0,6	2,75	WI010278	68,20 €
180	0,6	2,10	WI010279	75,40 €
200	0,8	3,45	WI010280	95,30 €
224	0,8	3,85	WI010281	105,40 €
250	0,8	4,30	WI010282	116,40 €
280	0,8	4,80	WI010283	129,10 €
300	0,8	6,10	WI010284	137,50 €
315	0,8	7,40	WI010285	143,80 €
355	0,8	8,30	WI010286	160,70 €
400	0,8	9,35	WI010287	179,70 €
450	0,8	10,50	WI010288	200,80 €
500	0,8	11,65	WI010289	224,70 €
560	0,8	13,00	WI010290	250,50 €
600	0,8	13,90	WI010291	267,40 €
630	1,0	18,20	WI010292	346,20 €
710	1,0	20,55	WI010293	388,40 €
800	1,0	23,10	WI010294	435,90 €
900	1,0	26,00	WI010295	488,70 €
1000	1,2	34,70	WI010296	681,60 €
1120	1,5	38,65	WI010297	760,60 €
1250	1,5	43,40	WI010298	846,30 €

Rohre und Formteile Edelstahl



Biessame Lüftungsrohre

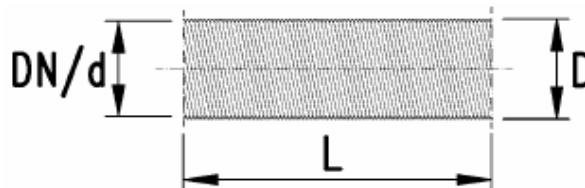

Biessame Lüftungsrohre

KFN 1.20.03

Konstruktion: 1-lagig

Werkstoff: 1.4436 / 1.4571

Nennweite (Innen DN) DN	D (Außen DN) mm	Gewicht kg/m	Bestell-Nr.	€/ Meter C
71	78	0,38	WI012504	48,20 €
75	83	0,43	WI012505	48,20 €
80	87	0,46	WI012506	48,20 €
100	107	0,57	WI012508	49,40 €
125	132	0,70	WI012512	56,60 €
140	147	0,79	WI012513	61,40 €
150	157	0,84	WI012514	61,40 €
160	167	1,90	WI012515	84,30 €
180	187	1,00	WI012516	84,30 €
200	210	1,11	WI012517	91,80 €
224	234	1,24	WI012518	102,40 €
250	260	1,39	WI012519	112,00 €
280	290	1,55	WI012520	115,60 €
300	310	1,66	WI012521	119,80 €
315	325	1,74	WI012522	128,10 €
355	365	1,96	WI012523	136,10 €
400	410	2,21	WI012524	141,90 €

Rohre und Formteile Edelstahl



Steckverbinder für Rohr
Steckverbinder für Formteil

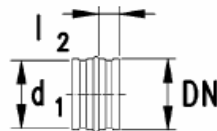

für Rohr VEB 5.10.13

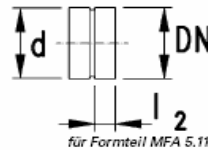

für Formteil MFA 5.11.13

Steckverbinder für Rohr VEB 5.10.13

inkl. Lippendichtung

Werkstoff: Edelstahl WSt. Nr. 1.4301

Nennweite	Gewicht	Bestell-Nr.	€/ Stück
DN	kg/Stk.		C
71	0,1	WI024701	17,10 €
80	0,1	WI024702	17,70 €
100	0,2	WI024704	17,80 €
125	0,2	WI024706	18,90 €
150	0,3	WI024708	19,20 €
160	0,3	WI024709	19,80 €
180	0,3	WI024710	21,60 €
200	0,4	WI024711	23,20 €
224	0,6	WI024712	24,50 €
250	0,7	WI024713	25,20 €
280	0,7	WI024714	26,50 €
300	0,8	WI024715	29,10 €
315	0,9	WI024716	30,90 €
355	1,0	WI024717	33,60 €
400	1,5	WI024718	41,70 €
450	1,7	WI024719	47,70 €
500	1,8	WI024720	55,20 €
560	2,1	WI024721	66,30 €
600	2,5	WI024722	75,70 €

Steckverbinder für Formteil MFA 5.11.13

Werkstoff: Edelstahl WSt. Nr. 1.4301

Nennweite	Gewicht	Bestell-Nr.	€/ Stück
DN	kg/Stk.		C
71	0,1	WI024901	14,00 €
80	0,1	WI024902	14,60 €
100	0,2	WI024903	14,60 €
125	0,2	WI024904	15,70 €
150	0,3	WI024905	15,70 €
160	0,3	WI024906	16,30 €
180	0,3	WI024907	18,00 €
200	0,4	WI024908	18,00 €
224	0,6	WI024909	19,20 €
250	0,7	WI024910	19,80 €
280	0,7	WI024911	20,40 €
300	0,8	WI024912	21,50 €
315	0,9	WI024913	23,30 €
355	1,0	WI024914	25,00 €
400	1,5	WI024915	32,00 €
450	1,7	WI024916	36,00 €
500	1,8	WI024917	43,00 €
560	2,1	WI024918	47,60 €
600	2,5	WI024919	54,00 €

Rohre und Formteile Edelstahl

Bundkragen

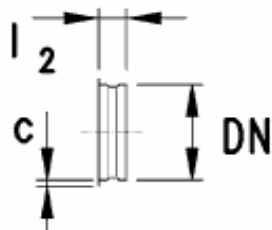

VEB 5.20.03



Bundkragen

VEB 5.20.03

inkl. Lippendichtung

Werkstoff: Edelstahl WSt. Nr. 1.4301

Nennweite	Gewicht	c min.	Bestell-Nr.	€/ Stück
DN	kg/Stk.	mm		C
71	0,1	6	WI024801	14,40 €
80	0,1	6	WI024802	15,00 €
100	0,1	6	WI024803	15,60 €
125	0,2	6	WI024804	15,60 €
150	0,2	6	WI024806	17,50 €
160	0,2	6	WI024807	18,10 €
180	0,3	6	WI024808	18,70 €
200	0,3	6	WI024809	20,60 €
224	0,3	8	WI024810	20,70 €
250	0,4	8	WI024811	22,50 €
280	0,5	8	WI024812	23,40 €
300	0,5	8	WI024813	25,30 €
315	0,7	8	WI024814	28,20 €
355	0,8	8	WI024815	31,00 €
400	0,9	8	WI024816	35,60 €
450	1,0	8	WI024817	40,70 €
500	1,5	10	WI024818	46,70 €
560	1,7	10	WI024819	53,50 €
600	1,8	10	WI024820	56,70 €

Rohre und Formteile Edelstahl

Schnellverbinder

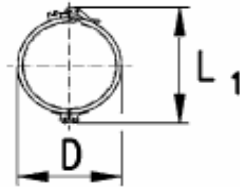

Schnellverbinder SSS 5.30.23



Schnellverbinder

SSS 5.30.23

Werkstoff: Edelstahl WSt. Nr. 1.4301

Nennweite	D	L1	Gewicht	Bestell-Nr.	€/ Stück
DN	mm	mm	kg/Stk.		C
71	87	125	0,3	WI028000	43,70 €
80	96	134	0,3	WI028001	43,70 €
100	116	154	0,3	WI028002	43,70 €
125	141	179	0,3	WI028003	47,60 €
150	166	204	0,3	WI028004	49,90 €
160	180	218	0,4	WI028005	50,90 €
180	200	238	0,4	WI028006	53,20 €
200	220	258	0,4	WI028007	54,40 €
224	244	282	0,4	WI028008	57,40 €
250	270	308	0,4	WI028009	60,30 €
280	300	338	0,5	WI028010	63,40 €
300	320	358	0,5	WI028011	66,40 €
315	335	373	0,5	WI028012	69,30 €
355	375	413	0,6	WI028013	75,80 €
400	420	458	0,7	WI028014	79,30 €
450	470	508	0,8	WI028015	82,70 €
500	520	558	0,9	WI028016	86,20 €
560	580	618	1,0	WI028017	100,50 €
600	620	658	1,1	WI028018	108,40 €

Rohre und Formteile verzinkt

Silikondichtung bis 220° C

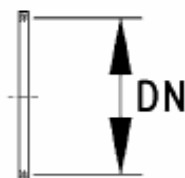

Silikondichtung DIM 5.34.18



Silikondichtung bis 220° C DIM 5.34.18

Nennweite	D	L1	Gewicht	Bestell-Nr.	€/ Stück
DN	mm	mm	kg/Stk		C
80	96	134	0,02	WI050240	5,10 €
100	116	154	0,02	WI050241	5,50 €
125	141	179	0,02	WI050242	5,90 €
150	166	204	0,03	WI050243	6,80 €
160	180	218	0,03	WI050244	7,10 €
180	200	238	0,03	WI050245	7,50 €
200	220	258	0,04	WI050246	8,00 €
224	244	282	0,04	WI050247	8,80 €
250	270	308	0,05	WI050248	9,20 €
280	300	338	0,05	WI050249	10,00 €
300	320	358	0,06	WI050250	10,40 €
315	335	373	0,06	WI050251	10,90 €
355	375	413	0,07	WI050252	12,10 €
400	420	458	0,08	WI050253	12,30 €
450	470	508	0,09	WI050254	14,10 €
500	520	558	0,10	WI050255	15,80 €
560	580	618	0,11	WI050256	17,50 €
600	620	658	0,12	WI050257	18,40 €
630	650	688	0,12	WI050258	19,10 €

Achtung! Nicht einsetzbar in Lackieranlagen, Automobilindustrie, o.ä.

Rohre und Formteile Edelstahl

Flachflansch entspricht DIN EN 122220,
DIN 24154 R1

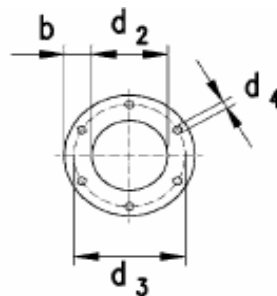

Flachflansch DIN 24154 R1

FRF 5.23.03

Werkstoff: Edelstahl WSt. Nr. 1.4301

Nennweite	d ₂	b x s	d ₃	d ₄	Lochanzahl	Schrauben	Gewicht	Bestell-Nr.	€/ Stück
DN	mm	mm	mm	mm			kg/Stk.		C
71	73	25 x 3	103	9,5	4	M8 x 25	0,16	WI028200	auf Anfrage
80	82		112				0,18	WI028201	
100	102		132				0,21	WI028202	
125	127		157				0,26	WI028203	
150	152	25 x 4	182	9,5	6	M8 x 25	0,43	WI028204	
160	162		192				0,46	WI028205	
180	182		212				0,51	WI028206	
200	203		233				0,56	WI028207	
224	227		257				0,62	WI028208	
250	253		283				0,69	WI028209	
280	283	30 x 4	317	9,5	8	M8 x 25	0,93	WI028210	
300	303		337				0,98	WI028211	
315	318		352				1,03	WI028212	
355	358		392				1,15	WI028213	
400	404		438				1,28	WI028214	
450	454		488				1,43	WI028215	
500	504		538				1,58	WI028216	
560	564	30 x 4	600	9,5	12	M8 x 25	2,07	WI028217	
600	604		640				2,20	WI028218	

Rohre und Formteile Edelstahl

Flachflansch entspricht DIN EN 122220,
DIN 24154 R2

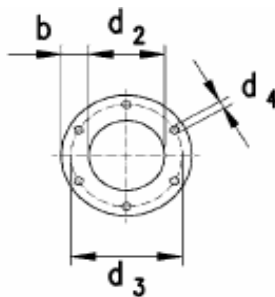

Flachflansch DIN 24154 R2

FRF 5.23.23

Werkstoff: Edelstahl WSt. Nr. 1.4301

Nennweite	d ₂	b x s	d ₃	d ₄	Lochanzahl	Schrauben	Gewicht	Bestell-Nr.	€/ Stück
DN	mm	mm	mm	mm			kg/Stk.		C
71	73	30 x 6	110	9,5	4	M8 x 25	0,44	WI028220	auf Anfrage
80	82		118				0,48	WI028221	
100	102		139				0,55	WI028222	
125	127		165				0,68	WI028223	
150	152	35 x 6	191	11,5	8	M10 x 25	0,93	WI028224	
160	162		200				0,98	WI028225	
180	182		219				1,08	WI028226	
200	203		241				1,19	WI028227	
224	227		265				1,32	WI028228	
250	253		292				1,45	WI028229	
280	283	40x 8	332	11,5	8	M10 x 25	2,51	WI028230	
300	303		349				2,75	WI028231	
315	318		366				2,98	WI028232	
355	358		405				3,10	WI028233	
400	404		448				3,44	WI028234	
450	454		497				3,84	WI02835	
500	504		551				4,13	WI028236	
560	564		629				5,90	WI028237	
600	604		665				6,20	WI028238	
									12
					16				

Rohre und Formteile Edelstahl

Bogen aus Segmenten 90°

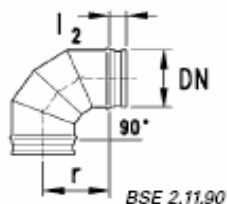

Bogen aus Segmenten 90°

BSE 2.11.90

inkl. Lippendichtung

Werkstoff: Edelstahl WSt. Nr. 1.4301

Nennweite	Gewicht	Bestell-Nr.	€/ Stück
DN	kg/Stk.		C
71	0,3	WI025101	94,20 €
80	0,4	WI025102	94,20 €
100	0,6	WI025104	94,30 €
125	0,7	WI025106	100,10 €
150	1,0	WI025108	110,20 €
160	1,1	WI025109	115,40 €
180	1,3	WI025110	120,20 €
200	1,6	WI025111	129,90 €
224	2,0	WI025112	142,70 €
250	2,5	WI025113	169,50 €
280	3,0	WI025114	190,50 €
300	3,6	WI025115	207,60 €
315	4,3	WI025116	222,10 €
355	5,3	WI025117	245,70 €
400	7,0	WI025118	264,80 €
450	8,6	WI025119	310,30 €
500	10,4	WI025120	383,80 €
560	12,9	WI025121	481,90 €
600	15,8	WI025122	597,30 €

Rohre und Formteile Edelstahl

Bogen aus Segmenten 60°

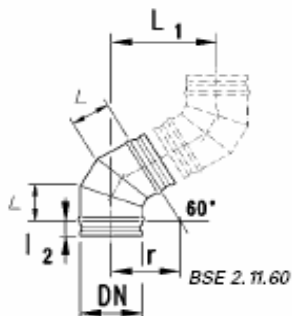

Bogen aus Segmenten 60°

BSE 2.11.60

inkl. Lippendichtung

Werkstoff: Edelstahl WSt. Nr. 1.4301

Nennweite	L	L1	Gewicht	Bestell-Nr.	€/ Stück
DN	mm	mm	kg/Stk.		C
71	40	150	0,3	WI025301	76,80 €
80	45	160	0,3	WI025302	76,80 €
100	58	180	0,4	WI025304	76,90 €
125	70	200	0,5	WI025306	82,70 €
150	80	230	0,7	WI025308	91,10 €
160	90	240	0,8	WI025309	95,70 €
180	105	260	1,0	WI025310	101,00 €
200	115	280	1,2	WI025311	108,40 €
224	130	300	1,5	WI025312	118,40 €
250	145	330	1,9	WI025313	139,40 €
280	160	395	2,3	WI025314	154,60 €
300	175	415	2,7	WI025315	171,10 €
315	180	430	3,1	WI025316	184,50 €
355	205	500	3,9	WI025317	199,90 €
400	230	550	5,2	WI025318	214,40 €
450	260	600	6,3	WI025319	251,10 €
500	290	650	7,6	WI025320	309,60 €
560	325	705	9,4	WI025321	389,10 €
600	350	750	11,4	WI025322	482,60 €

Rohre und Formteile Edelstahl

Bogen aus Segmenten 45°

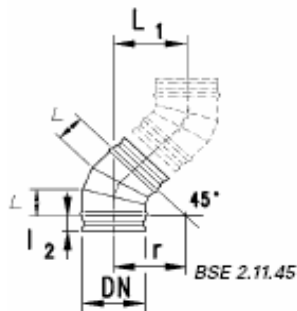

Bogen aus Segmenten 45°

BSE 2.11.45

inkl. Lippendichtung

Werkstoff: Edelstahl WSt. Nr. 1.4301

Nennweite	L	L1	Gewicht	Bestell-Nr.	€/ Stück
DN	mm	mm	kg/Stk.		C
71	30	105	0,2	WI025501	68,10 €
80	35	110	0,3	WI025502	68,10 €
100	40	125	0,4	WI025504	68,20 €
125	50	140	0,5	WI025506	72,80 €
150	60	150	0,6	WI025508	80,10 €
160	65	160	0,7	WI025509	83,00 €
180	75	170	0,8	WI025510	86,60 €
200	80	180	1,0	WI025511	92,80 €
224	95	195	1,2	WI025512	99,30 €
250	105	210	1,6	WI025513	112,10 €
280	115	255	1,9	WI025514	126,80 €
300	125	270	2,2	WI025515	127,30 €
315	130	275	2,6	WI025516	147,90 €
355	150	330	3,2	WI025517	160,50 €
400	165	355	4,3	WI025518	170,90 €
450	185	385	5,2	WI025519	205,40 €
500	210	415	6,2	WI025520	272,50 €
560	235	450	7,7	WI025521	342,80 €
600	250	470	9,3	WI025522	425,20 €

Rohre und Formteile Edelstahl

Bogen aus Segmenten 30°

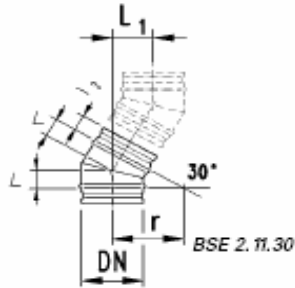

Bogen aus Segmenten 30°

BSE 2.11.30

inkl. Lippendichtung

Werkstoff: Edelstahl WSt. Nr. 1.4301

Nennweite	L	L1	Gewicht	Bestell-Nr.	€/ Stück
DN	mm	mm	kg/Stk.		C
71	20	65	0,2	WI025701	58,20 €
80	25	65	0,2	WI025702	58,20 €
100	30	70	0,3	WI025704	58,30 €
125	35	80	0,4	WI025706	62,40 €
150	40	85	0,5	WI025708	68,50 €
160	45	90	0,6	WI025709	71,40 €
180	50	95	0,7	WI025710	74,40 €
200	55	100	0,8	WI025711	79,50 €
224	60	105	1,0	WI025712	85,90 €
250	65	110	1,3	WI025713	99,90 €
280	75	140	1,5	WI025714	111,10 €
300	80	145	1,7	WI025715	123,00 €
315	85	150	2,0	WI025716	134,60 €
355	95	180	2,4	WI025717	148,90 €
400	110	195	3,4	WI025718	157,00 €
450	120	205	4,1	WI025719	185,10 €
500	135	220	4,8	WI025720	235,40 €
560	150	235	5,8	WI025721	297,00 €
600	160	245	7,0	WI025722	367,20 €

Rohre und Formteile Edelstahl

Bogen aus Segmenten 15°

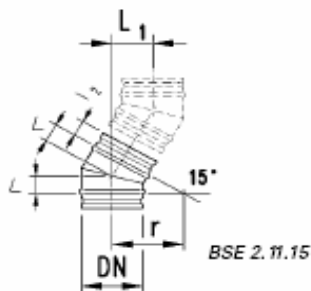

Bogen aus Segmenten 15°

BSE 2.11.15

inkl. Lippendichtung

Werkstoff: Edelstahl WSt. Nr. 1.4301

Nennweite DN	L mm	L1 mm	Gewicht kg/Stk.	Bestell-Nr.	€/ Stück C
71	10	30	0,2	WI025801	58,20 €
80	10	30	0,2	WI025802	58,20 €
100	15	30	0,3	WI025803	58,20 €
125	15	30	0,3	WI025804	62,40 €
150	20	35	0,4	WI025805	67,90 €
160	20	35	0,5	WI025806	70,80 €
180	25	35	0,5	WI025807	73,80 €
200	25	35	0,6	WI025808	78,90 €
224	30	40	0,8	WI025809	84,80 €
250	35	40	1,0	WI025810	98,80 €
280	40	55	1,2	WI025811	109,30 €
300	40	55	1,3	WI025812	121,30 €
315	45	55	1,5	WI025813	132,30 €
355	50	65	1,8	WI025814	146,00 €
400	55	70	2,6	WI025815	154,10 €
450	60	75	3,0	WI025816	181,00 €
500	65	75	3,5	WI025817	229,60 €
560	75	80	4,2	WI025818	288,90 €
600	80	85	5,0	WI025819	356,80 €

Segmentenanzahl

DN	Bogen 90°	Bogen 60° / 45°	Bogen 30° / 15°
70 - 315	4	3	2
355 - 710	5	3	2
800 - 1600	6	3	2

Rohre und Formteile Edelstahl

Abzweigstück 90°

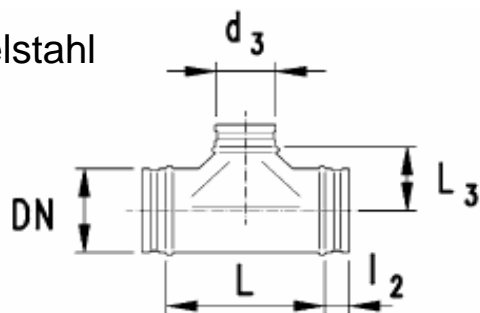

Abzweigstück 90°

ATE 3.10.90

inkl. Lippendichtung

Werkstoff: Edelstahl WSt. Nr. 1.4301

Nennweite	d3	L	L3	Gewicht	Bestell-Nr.	€/ Stück
DN		mm	mm	kg/Stk.		C
71	71	160	80	0,4	WI025901	50,10 €
80	71	160	85	0,5	WI025902	50,10 €
	80	170	85	0,5	WI025903	50,70 €
100	71	160	95	0,5	WI025904	52,50 €
	100	190	95	0,6	WI025905	54,30 €
125	71	160	110	0,7	WI025906	53,70 €
	125	215	110	0,9	WI025907	58,30 €
150	71	160	120	0,8	WI025908	58,60 €
	150	250	125	1,2	WI025909	68,50 €
160	71	160	125	0,8	WI025910	63,30 €
	160	260	130	1,3	WI025911	94,00 €
180	71	160	135	0,9	WI025912	67,40 €
	180	280	140	1,5	WI025913	108,60 €
200	80	170	145	1,1	WI025914	77,10 €
	200	330	165	1,9	WI025915	118,30 €
224	80	190	160	1,4	WI025916	88,80 €
	224	355	180	2,2	WI025917	121,90 €
250	100	190	170	1,6	WI025918	94,20 €
	250	380	190	2,8	WI025919	138,20 €
280	100	215	185	1,8	WI025920	98,90 €
	280	430	215	3,5	WI025921	155,70 €
300	100	215	195	2,4	WI025922	109,70 €
	300	450	225	4,2	WI025923	173,40 €
315	150	250	210	3,0	WI025924	129,40 €
	315	465	235	4,9	WI025925	189,70 €
355	150	250	230	3,4	WI025926	160,00 €
	355	525	265	6,1	WI025927	251,50 €
400	150	260	250	4,2	WI025928	175,50 €
	400	570	285	7,8	WI025929	288,60 €
450	200	450	300	7,1	WI025930	223,30 €
	400	570	310	8,7	WI025931	371,70 €
500	200	330	315	6,1	WI025932	255,10 €
	500	680	340	11,1	WI025933	423,20 €
560	300	450	355	8,7	WI025934	337,00 €
	560	740	370	13,2	WI025935	484,20 €
600	300	450	375	10,2	WI025936	365,50 €
	600	780	390	16,0	WI025937	532,40 €

Rohre und Formteile Edelstahl

Abzweigstück 45°

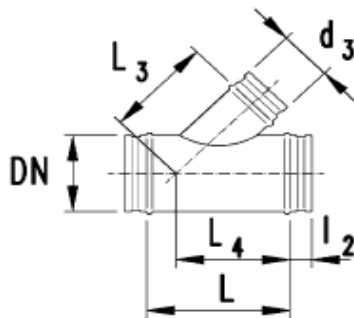

Abzweigstück 45°

AYE 3.10.45

inkl. Lippendichtung

Werkstoff: Edelstahl WSt. Nr. 1.4301

Nennweite	d3	L	L3	L4	Gewicht	Bestell-Nr.	€/ Stück
DN		mm	mm	mm	kg/Stk.		C
71	71	240	155	155	0,6	WI026101	73,90 €
80	71	240	160	160	0,6	WI026102	74,50 €
	80	250	165	165	0,7	WI026103	75,60 €
100	71	240	175	175	0,7	WI026104	77,50 €
	100	280	190	190	0,9	WI026105	80,40 €
125	71	240	195	180	0,9	WI026106	80,40 €
	125	340	220	210	1,3	WI026107	85,60 €
150	71	265	210	210	1,1	WI026108	87,00 €
	150	380	265	265	1,8	WI026109	101,50 €
160	71	265	215	200	1,1	WI026110	90,50 €
	160	390	275	275	1,9	WI026111	131,10 €
180	71	265	230	210	1,2	WI026112	92,90 €
	180	420	300	290	2,3	WI026113	143,90 €
200	80	280	250	225	1,3	WI026114	101,50 €
	200	450	325	325	2,8	WI026115	151,90 €
224	80	305	275	250	1,7	WI026116	116,70 €
	224	480	350	350	3,2	WI026117	158,40 €
250	100	305	295	265	2,1	WI026118	120,20 €
	250	520	385	385	4,1	WI026119	177,60 €
280	100	370	330	300	2,7	WI026120	126,70 €
	280	590	435	435	5,1	WI026121	197,40 €
300	100	370	350	335	3,1	WI026122	142,70 €
	300	615	460	460	6,7	WI026123	219,80 €
315	150	405	380	350	4,0	WI026124	164,20 €
	315	640	480	480	7,3	WI026125	240,70 €
355	150	405	410	370	4,4	WI026126	202,30 €
	355	695	525	525	8,8	WI026127	319,90 €
400	150	420	445	395	5,3	WI026128	226,00 €
	400	760	580	580	11,2	WI026129	366,80 €
450	200	475	500	450	6,9	WI026130	282,40 €
	450	830	640	640	13,5	WI026131	472,60 €
500	200	475	535	475	7,5	WI026132	323,50 €
	500	900	700	700	16,1	WI026133	537,40 €
560	300	665	640	615	11,4	WI026134	426,20 €
	560	1040	800	800	20,4	WI026135	615,20 €
600	300	665	665	635	13,1	WI026136	462,30 €
	600	1090	850	845	25,8	WI026137	667,40 €

Rohre und Formteile Edelstahl

Abzweigreduzierstück 90°

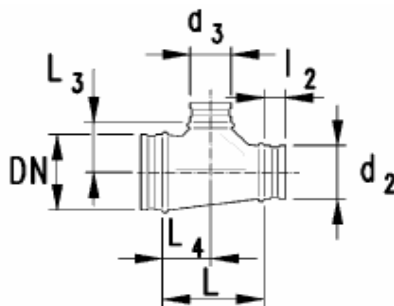

Abzweigreduzierstück 90°

ARE 3.11.90

inkl. Lippendichtung

Werkstoff: Edelstahl WSt. Nr. 1.4301

Nennweite	d2	d3	L	L3	L4	Gewicht	Bestell-Nr.	€/ Stück
DN			mm	mm	mm	kg/Stk.		C
80	71	71	285	85	80	0,6	WI026301	91,30 €
100	71	71	310	95	80	0,6	WI026302	97,20 €
125	80	80	345	110	85	0,8	WI026303	104,10 €
	100	100	335	110	95	0,9	WI026304	104,10 €
150	100	100	395	120	95	1,2	WI026305	119,50 €
	125	125	360	120	108	1,3	WI026306	119,50 €
160	125	125	375	125	108	1,3	WI026307	147,30 €
	150	150	370	130	125	1,5	WI026308	147,30 €
180	125	125	400	135	108	1,4	WI026309	165,40 €
	150	150	400	140	125	1,6	WI026310	165,40 €
200	125	125	430	145	108	1,6	WI026311	178,60 €
	150	150	425	150	125	1,9	WI026312	178,60 €
224	150	150	465	165	125	2,2	WI026313	186,80 €
	200	200	475	180	165	2,5	WI026314	186,80 €
250	150	150	500	175	125	2,5	WI026315	207,20 €
	200	200	510	190	165	3,0	WI026316	207,20 €
280	200	200	550	205	165	3,3	WI026317	229,30 €
	250	250	535	205	190	3,8	WI026318	229,30 €
300	200	200	615	215	165	3,9	WI026319	252,30 €
	250	250	595	215	190	4,4	WI026320	252,30 €
315	200	200	535	225	165	4,4	WI026321	276,60 €
	250	250	555	225	190	5,0	WI026322	276,60 €
355	250	250	635	245	190	5,6	WI026323	370,90 €
	315	315	670	255	233	6,7	WI026324	370,90 €
400	250	250	700	265	190	6,7	WI026325	436,40 €
	315	315	735	275	233	7,8	WI026326	436,40 €
450	250	250	770	315	190	8,5	WI026327	555,40 €
	355	355	850	310	263	9,6	WI026328	555,40 €
500	300	300	880	325	225	9,4	WI026329	633,00 €
	400	400	915	335	285	11,5	WI026330	633,00 €
560	300	300	990	355	225	10,4	WI026331	701,00 €
	400	400	990	365	285	12,8	WI026332	701,00 €
600	400	400	1035	385	285	15,0	WI026333	760,20 €
	500	500	1010	390	340	17,4	WI026334	760,20 €

Rohre und Formteile Edelstahl

Abzweigreduzierstück 45°

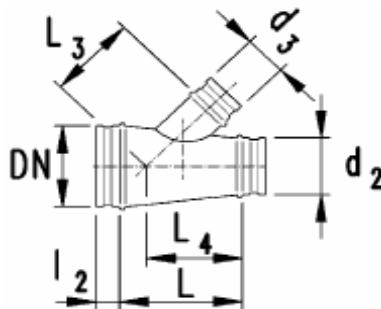

Abzweigreduzierstück 45°

ARE 3.11.45

inkl. Lippendichtung

Werkstoff: Edelstahl WSt. Nr. 1.4301

Nennweite	d2	d3	L	L3	L4	Gewicht	Bestell-Nr.	€/ Stück
DN			mm	mm	mm	kg/Stk.		C
80	71	71	365	160	285	0,75	WI026501	115,00 €
100	71	71	390	175	325	0,88	WI026502	122,10 €
125	80	80	425	200	360	1,13	WI026503	132,50 €
	100	100	425	210	345	1,38	WI026504	132,50 €
150	100	100	510	225	435	1,63	WI026505	149,10 €
	125	125	485	240	390	1,88	WI026506	149,10 €
160	125	125	500	245	395	1,88	WI026507	168,80 €
	150	150	500	270	390	2,25	WI026508	168,80 €
180	125	125	525	260	430	2,00	WI026509	191,50 €
	150	150	530	285	430	2,50	WI026510	191,50 €
200	125	125	555	270	475	2,25	WI026511	208,10 €
	150	150	555	300	465	2,63	WI026512	208,10 €
224	150	150	595	315	515	2,88	WI026513	218,10 €
	200	200	595	340	485	3,75	WI026514	218,10 €
250	150	150	630	335	565	3,50	WI026515	232,70 €
	200	200	630	360	530	4,25	WI026516	232,70 €
280	200	200	695	380	585	4,75	WI026517	257,10 €
	250	250	700	405	555	5,63	WI026518	257,10 €
300	200	200	760	395	670	5,50	WI026519	281,80 €
	250	250	760	420	635	6,50	WI026520	281,80 €
315	200	200	680	405	590	6,13	WI026521	314,30 €
	250	250	720	430	595	7,25	WI026522	314,30 €
355	250	250	800	460	695	7,88	WI026523	409,80 €
	315	315	845	505	705	9,75	WI026524	409,80 €
400	250	250	865	490	780	8,88	WI026525	492,00 €
	315	315	910	535	790	11,00	WI026526	492,00 €

Rohre und Formteile Edelstahl

Kragenstutzen 90°

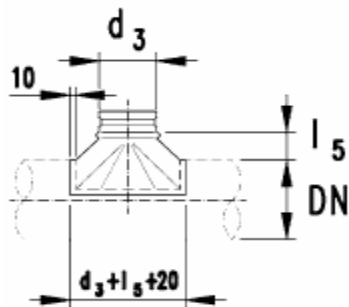

Kragenstutzen 90°

STE 3.21.90

inkl. Lippendichtung

Werkstoff: Edelstahl WSt. Nr. 1.4301

d3	Nennweite	L5	Gewicht	Bestell-Nr.	€/ Stück
	DN	mm	kg/Stk.		C
71	80	45	0,2	WI028301	79,70 €
80	80			WI028302	91,30 €
	100			WI028303	91,30 €
	150			WI028304	91,30 €
	180			WI028305	91,30 €
	200			WI028306	91,30 €
	250	45	0,3	WI028307	91,30 €
100	315	45	0,4	WI028308	91,30 €
	100			WI028309	92,50 €
	200			WI028310	92,50 €
125	315			WI028311	92,50 €
	125			WI028312	108,70 €
	180			WI028313	108,70 €
150	315			WI028314	108,70 €
	150			WI028315	109,60 €
	315			WI028316	109,60 €
160	160			WI028317	109,60 €
	250			WI028318	109,60 €
	355			WI028319	109,60 €
180	600	50	0,9	WI028320	117,30 €
	630	50	0,9	WI028321	117,30 €
200	200			WI028322	119,50 €
	250			WI028323	119,50 €
	315			WI028324	119,50 €
224	224			WI028325	130,60 €
	250			WI028326	130,60 €
250	250			WI028327	154,40 €
	280			WI028328	154,40 €
	450			WI028329	154,40 €
280	280	65	1,0	WI028330	171,40 €
	300	65	1,1	WI028331	171,40 €
300	300	65	1,2	WI028332	194,30 €
	400	65	1,4	WI028333	194,30 €
	630	65	1,9	WI028334	194,30 €

Rohre und Formteile Edelstahl

Kragenstutzen 45°

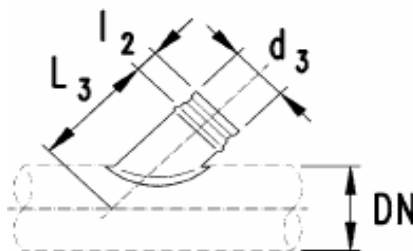

Kragenstutzen 45°

SYE 3.21.45

inkl. Lippendichtung

Werkstoff: Edelstahl WSt. Nr. 1.4301

d3	Nennweite DN	L3 mm	Gewicht kg/Stk.	Bestell-Nr.	€/ Stück C
71	80			WI028350	79,70 €
80	80			WI028351	91,30 €
	100	180	0,4	WI028352	91,30 €
	150	215	0,5	WI028353	91,30 €
	180	235	0,7	WI028354	91,30 €
	200			WI028355	91,30 €
	250	305	0,8	WI028356	91,30 €
	315			WI028357	91,30 €
100	100	190	0,4	WI028358	92,50 €
	200	260	0,5	WI028359	92,50 €
	315			WI028360	92,50 €
125	125	220	0,5	WI028361	108,70 €
	180			WI028362	108,70 €
	315			WI028363	108,70 €
150	150			WI028364	109,60 €
	315	380	0,9	WI028365	109,60 €
160	160	275	0,5	WI028366	109,60 €
	250	340	0,8	WI028367	109,60 €
	355	415	1,0	WI028368	109,60 €
180	180	300	0,7	WI028369	117,30 €
	224			WI028370	117,30 €
200	200			WI028371	119,50 €
	250	360	0,8	WI028372	119,50 €
	315			WI028373	119,50 €
224	224			WI028374	130,60 €
	250	370	0,8	WI028375	130,60 €
250	250			WI028376	154,40 €
	280			WI028377	154,40 €
	450	525	1,4	WI028378	154,40 €
280	280			WI028379	171,40 €
	300			WI028380	171,40 €
300	300			WI028381	194,30 €
	400			WI028382	194,30 €
	630			WI028383	194,30 €

Rohre und Formteile Edelstahl

Übergangsstück symmetrisch

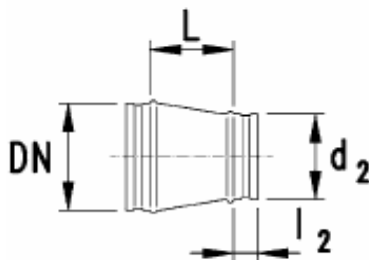

Übergangsstück symmetrisch

USE 4.10.03

inkl. Lippendichtung

Werkstoff: Edelstahl WSt. Nr. 1.4301

Nennweite	d2	L	Gewicht	Bestell-Nr.	€/ Stück
DN		mm	kg/Stk.		C
80	50	30	0,1	WI026902	45,30 €
	63	25	0,1	WI026903	48,40 €
	71	20	0,1	WI026904	48,40 €
100	50	35	0,2	WI026905	48,80 €
	63	30	0,2	WI026906	51,90 €
	71	25	0,2	WI026907	51,90 €
	80	25	0,1	WI026908	51,90 €
125	71	105	0,3	WI026909	55,40 €
	80	40	0,2	WI026910	55,40 €
	100	20	0,2	WI026911	55,40 €
150	80	130	0,4	WI026912	60,80 €
	100	45	0,3	WI026913	60,80 €
	125	25	0,3	WI026914	60,80 €
160	80	140	0,5	WI026915	63,70 €
	100	55	0,3	WI026916	63,70 €
	125	45	0,3	WI026917	63,70 €
	150	20	0,3	WI026918	63,90 €
180	80	170	0,5	WI026919	67,20 €
	100	60	0,3	WI026920	67,20 €
	125	45	0,3	WI026921	67,20 €
	150	30	0,3	WI026922	67,40 €
	160	25	0,3	WI026923	67,40 €
200	80	195	0,6	WI026924	72,00 €
	100	70	0,4	WI026925	72,10 €
	125	55	0,4	WI026926	72,10 €
	150	40	0,4	WI026927	72,20 €
	160	35	0,4	WI026928	72,20 €
	180	25	0,4	WI026929	72,30 €
224	100	205	0,8	WI026930	76,80 €
	125	165	0,8	WI026931	76,80 €
	150	55	0,5	WI026932	76,90 €
	160	65	0,4	WI026933	76,90 €
	180	55	0,4	WI026934	77,00 €
	200	25	0,4	WI026935	77,80 €
250	100	235	1,0	WI026936	82,60 €
	125	200	1,0	WI026937	82,60 €
	150	70	0,5	WI026938	82,80 €
	160	65	0,5	WI026939	82,80 €
	180	55	0,5	WI026940	82,80 €
	200	45	0,5	WI026941	83,60 €
	224	30	0,5	WI026942	83,70 €

Rohre und Formteile Edelstahl

Übergangsstück symmetrisch

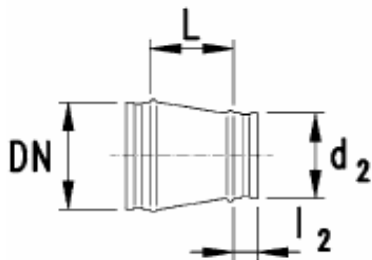

Übergangsstück symmetrisch

USE 4.10.03

inkl. Lippendichtung

Werkstoff: Edelstahl WSt. Nr. 1.4301

Nennweite	d2	L	Gewicht	Bestell-Nr.	€/ Stück
DN		mm	kg/Stk.		C
280	125	240	1,2	WI026943	88,20 €
	150	205	1,2	WI026944	88,30 €
	160	195	1,1	WI026945	88,30 €
	180	165	1,1	WI026946	88,40 €
	200	60	0,6	WI026947	89,20 €
	224	45	0,6	WI026948	89,20 €
	250	30	0,6	WI026949	89,30 €
300	125	270	1,3	WI026950	94,20 €
	150	235	1,3	WI026951	94,30 €
	160	220	1,2	WI026952	94,30 €
	180	190	1,2	WI026953	94,40 €
	200	60	0,9	WI026954	95,20 €
	224	55	0,9	WI026955	95,20 €
	250	45	0,9	WI026956	95,30 €
	280	25	0,9	WI026957	95,60 €
315	150	260	1,8	WI026958	103,00 €
	160	100	0,9	WI026959	103,00 €
	180	215	1,6	WI026960	103,00 €
	200	80	0,9	WI026961	103,80 €
	224	65	0,9	WI026962	103,90 €
	250	50	0,9	WI026963	103,90 €
	280	30	0,9	WI026964	104,30 €
	300	15	0,8	WI026965	105,00 €
355	150	315	2,3	WI026966	118,00 €
	160	300	2,2	WI026967	118,00 €
	180	270	2,1	WI026968	118,00 €
	200	245	2,0	WI026969	118,80 €
	224	210	1,9	WI026970	118,90 €
	250	175	1,8	WI026971	118,90 €
	280	135	1,7	WI026972	119,30 €
	300	110	1,5	WI026973	120,00 €
315	85	1,4	WI026974	120,00 €	
400	200	310	2,7	WI026975	152,40 €
	224	275	2,6	WI026976	152,50 €
	250	240	2,6	WI026977	152,50 €
	280	200	2,4	WI026978	152,90 €
	300	165	2,3	WI026979	153,60 €
	315	150	2,2	WI026980	153,60 €
	355	100	1,9	WI026981	154,10 €

Rohre und Formteile Edelstahl

Übergangsstück asymmetrisch

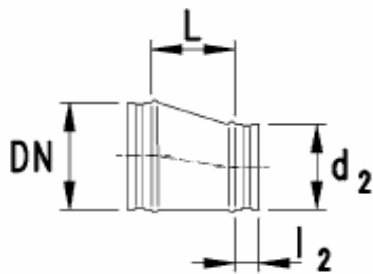

Übergangsstück asymmetrisch

UAE 4.10.03

inkl. Lippendichtung

Werkstoff: Edelstahl WSt. Nr. 1.4301

Nennweite	d2	L	Gewicht	Bestell-Nr.	€/ Stück
DN		mm	kg/Stk.		C
80	50	45	0,2	WI027102	47,60 €
	63			WI027103	50,70 €
	71			WI027104	50,70 €
100	50	70	0,2	WI027105	50,50 €
	63			WI027106	53,70 €
	71			WI027107	53,70 €
	80			WI027108	53,70 €
125	71	105	0,3	WI027109	57,70 €
	80	95	0,3	WI027110	57,70 €
	100	65	0,3	WI027111	57,80 €
150	80	130	0,4	WI027112	63,10 €
	100	125	0,4	WI027113	63,10 €
	125	65	0,3	WI027114	63,10 €
160	80	140	0,5	WI027115	66,60 €
	100	110	0,4	WI027116	66,60 €
	125	80	0,4	WI027117	66,60 €
	150	40	0,4	WI027118	66,80 €
180	80	170	0,5	WI027119	70,10 €
	100	140	0,5	WI027120	70,10 €
	125	105	0,5	WI027121	70,10 €
	150	70	0,4	WI027122	70,30 €
	160	60	0,4	WI027123	70,30 €
200	80	195	0,6	WI027124	75,50 €
	100	165	0,6	WI027125	75,60 €
	125	135	0,6	WI027126	75,60 €
	150	95	0,5	WI027127	75,70 €
	160	85	0,5	WI027128	75,70 €
	180	55	0,5	WI027129	75,80 €
224	100	205	0,8	WI027130	80,30 €
	125	165	0,8	WI027131	80,30 €
	150	135	0,7	WI027132	80,40 €
	160	120	0,7	WI027133	80,40 €
	180	90	0,6	WI027134	80,50 €
250	200	65	0,5	WI027135	81,30 €
	100	235	1,0	WI027136	86,10 €
	125	200	1,0	WI027137	86,10 €
	150	170	0,9	WI027138	86,20 €
	160	155	0,9	WI027139	86,20 €
	180	125	0,9	WI027140	86,30 €
	200	100	0,8	WI027141	87,10 €
224	65	0,7	WI027142	87,10 €	

Rohre und Formteile Edelstahl

Übergangsstück asymmetrisch

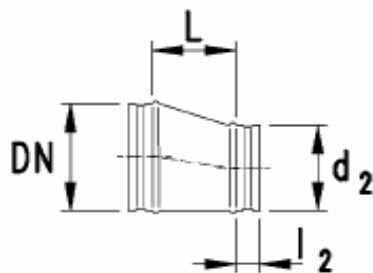

Übergangsstück asymmetrisch

UAE 4.10.03

inkl. Lippendichtung

Werkstoff: Edelstahl WSt. Nr. 1.4301

Nennweite	d2	L	Gewicht	Bestell-Nr.	€/ Stück
DN		mm	kg/Stk.		C
280	125	240	1,2	WI027143	91,70 €
	150	205	1,2	WI027144	91,80 €
	160	195	1,1	WI027145	91,80 €
	180	165	1,1	WI027146	91,90 €
	200	140	1,0	WI027147	92,70 €
	224	105	0,9	WI027148	92,70 €
	250	75	0,9	WI027149	92,80 €
300	125	270	1,3	WI027150	98,20 €
	150	235	1,3	WI027151	98,40 €
	160	220	1,2	WI027152	98,40 €
	180	190	1,2	WI027153	98,40 €
	200	165	1,2	WI027154	99,20 €
	224	130	1,1	WI027155	99,30 €
	250	95	1,0	WI027156	99,30 €
	280	55	0,9	WI027157	99,70 €
315	150	260	1,8	WI027158	107,60 €
	160	245	1,7	WI027159	107,60 €
	180	215	1,6	WI027160	107,70 €
	200	190	1,5	WI027161	108,50 €
	224	155	1,4	WI027162	108,50 €
	250	120	1,4	WI027163	108,60 €
	280	80	1,2	WI027164	108,90 €
	300	50	1,2	WI027165	109,70 €
355	150	315	2,3	WI027166	123,80 €
	160	300	2,2	WI027167	123,80 €
	180	270	2,1	WI027168	123,80 €
	200	245	2,0	WI027169	124,60 €
	224	210	1,9	WI027170	124,70 €
	250	175	1,8	WI027171	124,70 €
	280	135	1,7	WI027172	125,10 €
	300	110	1,5	WI027173	125,80 €
315	85	1,4	WI027174	125,80 €	
400	200	310	2,7	WI027175	158,20 €
	224	275	2,6	WI027176	158,30 €
	250	240	2,6	WI027177	158,30 €
	280	200	2,4	WI027178	158,70 €
	300	165	2,3	WI027179	159,40 €
	315	150	2,2	WI027180	159,40 €
	355	100	1,9	WI027181	159,90 €

Rohre und Formteile Edelstahl



Deckel für Rohr
Deckel für Formteil

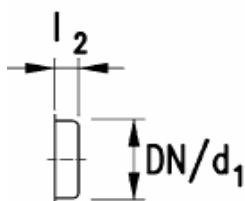

DRE 6.10.13

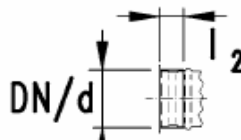

DFA 6.11.13

Deckel für Rohr

DRE 6.10.13

inkl. Lippendichtung

Werkstoff: Edelstahl WSt. Nr. 1.4301

Nennweite	Gewicht	Bestell-Nr.	€/ Stück
DN	kg/Stk.		C
71	0,1	WI027301	22,50 €
80	0,1	WI027302	22,50 €
100	0,1	WI027303	24,30 €
125	0,1	WI027304	26,00 €
150	0,1	WI027305	29,60 €
160	0,2	WI027306	29,60 €
180	0,2	WI027307	30,90 €
200	0,2	WI027308	36,30 €
224	0,3	WI027309	36,30 €
250	0,4	WI027310	44,50 €
280	0,4	WI027311	46,60 €
300	0,5	WI027312	55,50 €
315	0,6	WI027313	58,40 €
355	0,7	WI027314	64,70 €
400	0,8	WI027315	71,60 €
450	1,8	WI027316	88,80 €
500	2,1	WI027317	100,60 €
560	2,6	WI027318	115,50 €
600	3,2	WI027319	158,10 €

Deckel für Formteil

DFA 6.11.13

Werkstoff: Edelstahl WSt. Nr. 1.4301

Nennweite	Gewicht	Bestell-Nr.	€/ Stück
DN	kg/Stk.		C
71	0,1	WI027320	20,90 €
80	0,1	WI027321	20,90 €
100	0,1	WI027322	22,70 €
125	0,1	WI027323	24,40 €
150	0,1	WI027324	27,90 €
160	0,2	WI027325	27,90 €
180	0,2	WI027326	29,10 €
200	0,2	WI027327	33,70 €
224	0,3	WI027328	33,70 €
250	0,4	WI027329	41,80 €
280	0,4	WI027330	43,50 €
300	0,5	WI027331	51,70 €
315	0,6	WI027332	54,60 €
355	0,7	WI027333	60,40 €
400	0,8	WI027334	66,70 €
450	1,8	WI027335	83,00 €
500	2,1	WI027336	94,50 €
560	2,6	WI027337	106,10 €
600	3,2	WI027338	147,30 €

Rohre und Formteile Edelstahl

Deflektorhaube

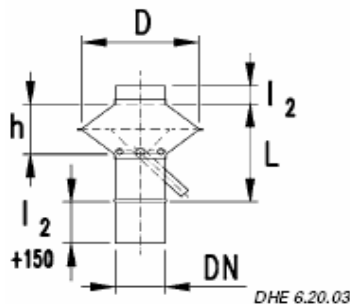

Deflektorhaube

DHE 6.20.03

inkl. Lippendichtung

Werkstoff: Edelstahl WSt. Nr. 1.4301

Nennweite	D	h	L	Gewicht	Bestell-Nr.	€/ Stück
DN	mm	mm	mm	kg/Stk.		C
100	240	110	210	1,9	WI022840	337,80 €
125	280	120	220	2,2	WI022841	350,00 €
150	310	135	235	2,3	WI022842	365,80 €
160	330	140	240	3,1	WI022843	354,50 €
180	350	145	245	3,7	WI022844	466,10 €
200	380	170	270	4,6	WI022845	498,80 €
224	400	200	300	6,0	WI022846	518,00 €
250	450	230	330	7,3	WI022847	572,50 €
280	490	260	360	8,9	WI022848	698,10 €
300	520	280	380	10,2	WI022849	744,80 €
315	540	300	400	11,2	WI022850	786,30 €
355	590	350	450	14,4	WI022851	884,20 €
400	650	400	500	18,2	WI022852	1.008,20 €
450	720	460	560	22,5	WI022853	1.196,40 €
500	790	520	620	27,4	WI022854	1.354,30 €
560	870	570	670	43,1	WI022855	1.632,30 €
600	920	620	720	49,1	WI022856	1.908,50 €

Rohre und Formteile Edelstahl

Abdeckhaube

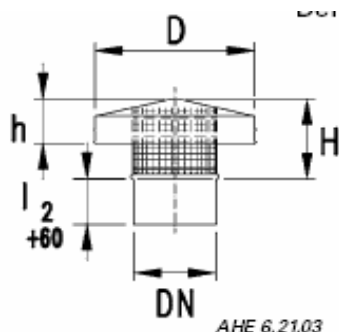

AHE 6.21.03

Abdeckhaube

AHE 6.21.03

inkl. Lippendichtung

Werkstoff: Edelstahl WSt. Nr. 1.4301

Nennweite	D	H	h	Gewicht	Bestell-Nr.	€/ Stück
DN	mm	mm	mm	kg/Stk.		C
100	210	100	68	0,8	WI023240	190,60 €
125	250	108	74	1,0	WI023241	204,50 €
150	280	115	88	1,2	WI023242	223,20 €
160	290	120	90	1,3	WI023243	230,20 €
180	320	125	93	2,5	WI023244	244,70 €
200	350	130	107	2,8	WI023245	259,40 €
224	400	150	114	3,2	WI023246	277,50 €
250	460	180	142	3,6	WI023247	293,70 €
280	500	185	147	4,6	WI023248	318,10 €
300	545	190	153	5,0	WI023249	337,10 €
315	570	195	156	5,4	WI023250	360,30 €
355	600	195	160	6,5	WI023251	406,00 €
400	640	205	166	7,8	WI023252	468,00 €
450	720	235	196	10,6	WI023253	568,70 €
500	780	280	224	12,5	WI023254	682,60 €
560	860	310	255	17,9	WI023255	848,70 €
600	1080	330	284	20,1	WI023256	931,30 €

Rohre und Formteile Edelstahl

Wetterkragen

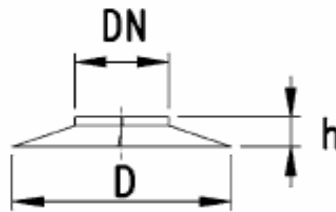

WTK 6.52.03



Wetterkragen

WTK 6.52.03

Werkstoff: Edelstahl WSt. Nr. 1.4301

Nennweite	NG	D	H	Gewicht	Bestell-Nr.	€/ Stück
DN		mm	mm	kg/Stk.		C
71	71	270	50	0,1	WI024040	29,10 €
80	80	280	50	0,1	WI024041	29,60 €
100	100	300	50	0,1	WI024042	30,20 €
125	125	325	50	0,2	WI024043	32,00 €
150	150	350	50	0,3	WI024044	32,50 €
160	160	360	50	0,3	WI024045	33,70 €
180	180	380	50	0,3	WI024046	33,70 €
200	200	400	50	0,4	WI024047	36,60 €
224	224	425	50	0,4	WI024048	38,90 €
250	250	450	50	0,4	WI024049	41,80 €
280	280	480	50	0,5	WI024050	43,50 €
300	300	500	50	0,5	WI024051	43,50 €
315	315	515	50	0,5	WI024052	46,40 €
355	355	555	50	0,6	WI024053	46,40 €
400	400	600	50	0,7	WI024054	52,80 €
450	450	650	50	0,8	WI024055	67,90 €
500	500	700	50	1,0	WI024056	67,90 €
560	560	760	50	1,0	WI024057	87,00 €
600	600	800	50	1,1	WI024058	87,00 €

Rohre und Formteile Edelstahl

Führungsstutzen für Flachdach

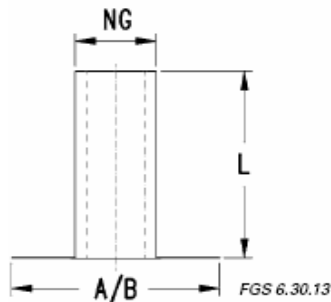

Führungsstutzen für Flachdach

FGS 6.30.13

Werkstoff: Edelstahl WSt. Nr. 1.4301

Nennweite	NG	A / B	L	D	Gewicht	Bestell-Nr.	€/ Stück
DN		mm	mm	mm	kg/Stk.		C
71	100	350 / 350	400	160	0,9	WI028401	94,00 €
80	100	350 / 350	400	160	0,9	WI028402	94,00 €
100	125	350 / 350	400	180	1,1	WI028403	115,40 €
125	150	350 / 350	400	224	1,3	WI028404	145,00 €
150	180	350 / 350	400	250	1,5	WI028405	161,20 €
160	180	350 / 350	400	250	1,5	WI028406	161,20 €
180	200	530 / 530	400	280	1,7	WI028407	168,20 €
200	224	530 / 530	400	280	1,9	WI028408	173,40 €
224	250	530 / 530	400	315	2,2	WI028409	182,10 €
250	280	530 / 530	400	355	2,4	WI028410	193,70 €
280	300	530 / 530	400	355	3,1	WI028411	223,80 €
300	315	710 / 710	400	400	3,7	WI028412	223,80 €
315	355	710 / 710	400	400	4,2	WI028413	259,70 €
355	400	710 / 710	400	450	4,7	WI028414	259,70 €
400	450	710 / 710	400	500	5,3	WI028415	287,00 €
450	500	710 / 710	400	560	5,8	WI028416	350,70 €
500	560	710 / 710	400	630	6,5	WI028417	350,70 €
560	600	850 / 850	400	710	7,0	WI028418	420,90 €
600	630	850 / 850	400	710	9,1	WI028419	420,90 €

Rohre und Formteile Edelstahl

Ausblasestutzen gerade mit Schutzgitter

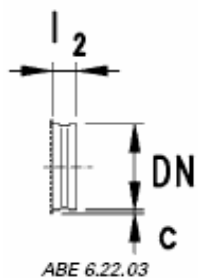

Ausblasestutzen gerade mit Schutzgitter

ABE 6.22.03

inkl. Lippendichtung

Werkstoff: Edelstahl WSt. Nr. 1.4301

Nennweite	c min.	Gewicht	Bestell-Nr.	€/ Stück
DN	mm	kg/Stk.		C
71	6	0,15	WI027501	62,50 €
80	6	0,15	WI027502	62,50 €
100	6	0,25	WI027504	73,50 €
125	6	0,25	WI027506	83,40 €
150	6	0,35	WI027508	94,00 €
160	6	0,35	WI027509	102,10 €
180	6	0,35	WI027510	105,00 €
200	6	0,45	WI027511	114,00 €
224	8	0,70	WI027512	116,90 €
250	8	0,80	WI027513	129,10 €
280	8	0,80	WI027514	130,60 €
300	8	0,95	WI027515	144,10 €
315	8	1,05	WI027516	153,40 €
355	8	1,15	WI027517	167,80 €
400	8	1,75	WI027518	182,90 €
450	8	1,95	WI027519	202,40 €
500	10	2,10	WI027520	225,30 €
560	10	2,42	WI027521	244,70 €
600	10	2,88	WI027522	268,80 €

Rohre und Formteile Edelstahl

Ausblasestutzen 45° mit Schutzgitter

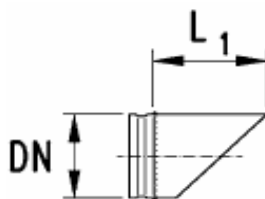

ABE 6.22.23



Ausblasestutzen 45° mit Schutzgitter

ABE 6.22.23

inkl. Lippendichtung

Werkstoff: Edelstahl WSt. Nr. 1.4301

Nennweite	c min.	L1	Gewicht	Bestell-Nr.	€/ Stück
DN	mm	mm	kg/Stk.		C
71	6	171	0,2	WI027701	133,20 €
80	6	180	0,2	WI027702	133,20 €
100	6	200	0,3	WI027704	145,40 €
125	6	225	0,4	WI027706	155,80 €
150	6	250	0,6	WI027708	169,30 €
160	6	260	0,6	WI027709	180,30 €
180	6	280	0,7	WI027710	184,40 €
200	6	300	0,8	WI027711	197,40 €
224	8	324	1,0	WI027712	207,30 €
250	8	350	1,2	WI027713	241,60 €
280	8	380	1,4	WI027714	264,50 €
300	8	400	1,6	WI027715	283,20 €
315	8	415	1,9	WI027716	312,80 €
355	8	455	2,3	WI027717	341,70 €
400	8	500	2,9	WI027718	386,30 €
450	8	550	3,4	WI027719	387,30 €
500	10	600	4,0	WI027720	442,60 €
560	10	660	4,9	WI027721	496,90 €
600	10	700	5,5	WI027722	574,90 €

Rohre und Formteile Edelstahl

Ausblasebogen 90° mit Schutzgitter

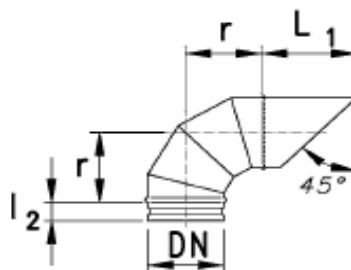

ABE 6.23.03



Ausblasebogen 90° mit Schutzgitter

ABE 6.23.03

inkl. Lippendichtung

Werkstoff: Edelstahl WSt. Nr. 1.4301

Nennweite	L1	Gewicht	Bestell-Nr.	€/ Stück
DN	mm	kg/Stk.		C
71	171	0,5	WI024340	149,10 €
80	180	0,6	WI024341	149,80 €
100	200	0,9	WI024342	149,80 €
125	225	1,1	WI024343	159,70 €
150	250	1,6	WI024344	189,90 €
160	260	1,7	WI024345	189,90 €
180	280	2,0	WI024346	173,10 €
200	300	2,4	WI024347	200,90 €
224	324	3,0	WI024348	210,70 €
250	350	3,7	WI024349	218,50 €
280	380	4,4	WI024350	220,40 €
300	400	5,2	WI024351	253,30 €
315	415	6,2	WI024352	271,90 €
355	455	7,5	WI024353	312,80 €
400	500	9,9	WI024354	414,20 €
450	550	12,0	WI024355	489,70 €
500	600	14,4	WI024356	674,20 €
560	660	17,8	WI024357	770,60 €
600	700	21,3	WI024358	918,10 €

Rohre und Formteile Edelstahl

Reinigungsöffnung mit Revisionsdeckel

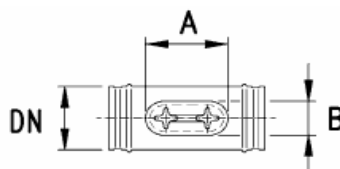

REE 6.25.43

Reinigungsöffnung mit Revisionsdeckel

REE 6.25.43

inkl. Lippendichtung

Werkstoff: Edelstahl WSt. Nr. 1.4301

Nennweite	A / B	L	Gewicht	Bestell-Nr.	€/ Stück
DN	mm	mm	kg/Stk.		C
71	180 / 80	250	0,7	WI100101	146,90 €
80	180 / 80	250	0,7	WI100102	146,90 €
100	180 / 80	250	0,7	WI100103	148,80 €
125	180 / 80	250	0,8	WI100104	151,10 €
150	180 / 80	250	1,1	WI100105	156,00 €
160	200 / 100	250	1,2	WI100106	179,20 €
180	200 / 100	250	1,3	WI100107	186,80 €
200	200 / 100	270	1,5	WI100108	192,50 €
224	200 / 100	270	1,7	WI100109	194,30 €
250	200 / 100	270	2,2	WI100110	202,50 €
280	200 / 100	270	2,6	WI100111	211,40 €
300	200 / 100	270	2,9	WI100112	221,00 €
315	200 / 100	270	3,1	WI100113	229,10 €
355	200 / 100	270	3,7	WI100114	260,80 €
400	300 / 200	270	4,1	WI100115	339,00 €
450	300 / 200	400	5,1	WI100116	381,60 €
500	300 / 200	400	6,1	WI100117	407,60 €
560	400 / 300	400	7,5	WI100118	517,20 €
600	400 / 300	400	8,0	WI100119	542,80 €

Drosselklappe

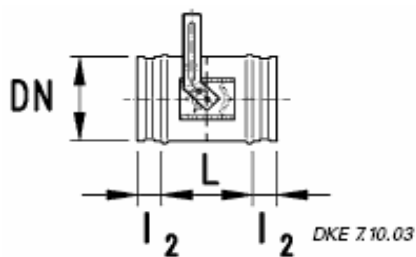

Drosselklappe

DKE 7.10.03

inkl. Lippendichtung

Werkstoff: Edelstahl WSt. Nr. 1.4301

Nennweite	L	Gewicht	Bestell-Nr.	€/ Stück
DN	mm	kg/Stk.		C
71	170	0,4	WI028101	91,30 €
80	170	0,4	WI028102	91,90 €
100	170	0,5	WI028104	97,20 €
125	170	0,8	WI028106	110,50 €
150	170	1,1	WI028108	118,30 €
160	170	1,4	WI028109	120,70 €
180	170	1,7	WI028110	123,10 €
200	170	2,0	WI028111	128,70 €
224	170	2,3	WI028112	134,60 €
250	170	2,8	WI028113	144,00 €
280	130	3,4	WI028114	153,40 €
300	130	3,8	WI028115	168,80 €
315	130	4,2	WI028116	182,70 €
355	170	5,1	WI028117	204,00 €
400	170	6,4	WI028118	257,30 €
450	170	8,9	WI028119	352,60 €
500	170	10,7	WI028120	398,90 €
560	300	13,2	WI028121	460,40 €
600	300	15,0	WI028122	497,60 €